



位址: 香港九龍新浦崗大有街29號宏基中心1407室

電話 +852 36934218

傳真 +852 37436367

位址: 廣東省深圳市福田區深南大道南 泰然九路喜年中心A座1720室

電話 +86 (755) 86538552 傳真 +86 (755) 26653184

ABT-P13-50013-173

Balun Trasformer(20-4500MHz)

**DESCRIPTION**

**SCOPE**

- ABT-P13-50013-173 is a 1:3 balun transformer in a SMT package.

**APPLICATIONS**

- Ideally suitable for PCS, wideband push-pull amplifiers and cellular applications.

**FEATURES**

- Surface mount
- Impedance ratio: 1:3
- Balanced transmission line
- RoHS compliant
- 260°C reflow compatible

**PART NUMBER**

ABT - P13 - 50013 - 173  
 ①② - ③④ - ⑤ - ⑥

- ① Apps Electronics Limited
- ② Product series
- ③ Form Factor
- ④ Size Number
- ⑤ Impedance/Ratio
- ⑥ Design series Code

**Form Factor**  
 B: Bobbin/Pin Base  
**P: PCB base**  
 C: Ceramic base or SMD core  
 F: Ferrite SMD core  
 Other...  
**13: Form sequence code**  
**50013: 50 ohm, 1 : 3 Ratio**  
**173: Design series Code**

Series	Function description
<b>BT/BL/WB</b>	<b>Balun Transformer</b>
PD/PS	Power Divider/Power Splitter
PC	Power Combiner
CP	Directional Coupler, branch line hybrid/coupler
CL	Coupler+LPF
TF	RF Transformer(non-Balun, SE/SE, BA/BA)
LP/HP/BP/DP/TP	Filter(Lowpass/Highpass/Bandpass/Diplexer/Triplexer)
PT/PM	Power Transformer/Power Module
CM	C.M. Choke
E	Lan Transformer/RJ45/Air Coil
Other...	

**FUNCTIONAL SCHEMATIC**

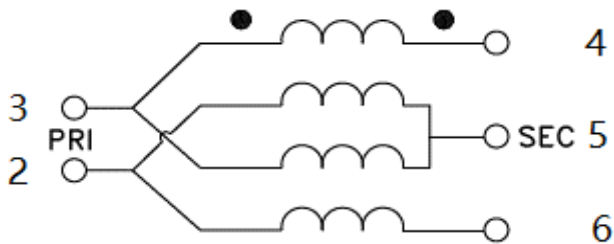

**PIN CONFIGURATION**

Pin No.	Function
1	Not used(ground)
2	Primary(Ground)
3	Primary Dot
4	Secondary Dot
5	Ground
6	Secondary



# Appse Electronics Limited

## 雅思電子有限公司

位址: 香港九龍新浦崗大有街29號宏基中心1407室

電話 +852 36934218

傳真 +852 37436367

位址: 廣東省深圳市福田區深南大道南 泰然九路喜年中心A座1720室

電話 +86 (755) 86538552 傳真 +86 (755) 26653184

ABT-P13-50013-173

Balun Trasformer(20-4500MHz)

### DIMENSIONS

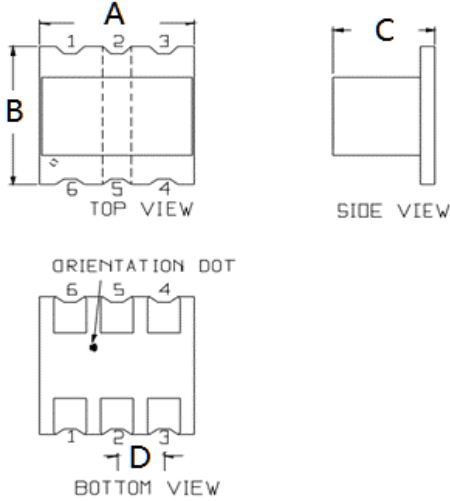

A	B	C
4.30	4.30	3.00
D		
1.27		

Unless otherwise stated dimensions are in mm

Tolerance: .xx ± 0.25, .xxx ± 0.05

### RECOMMENED LAND PATTERN

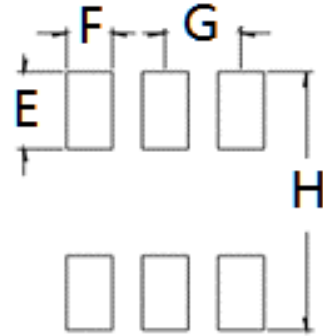

E	F	G
1.40	0.76	1.27
H		
4.83		

### APPLICATION & TEST CIRCUIT

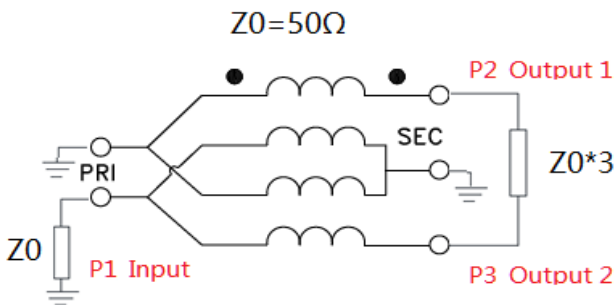

### ABSOLUTE MAXIMUM RATINGS

Parameter	Value
RF Power	0.4W
DC Current	30mA
Operating Temperature Range	-40 to 85°C
Storage Temperature Range	-55 to 100°C



# Apps Electronics Limited

## 雅思電子有限公司

位址：香港九龍新浦崗大有街29號宏基中心1407室

電話 +852 36934218

傳真 +852 37436367

位址：廣東省深圳市福田區深南大道南 泰然九路喜年中心A座1720室

電話 +86 (755) 86538552 傳真 +86 (755) 26653184

ABT-P13-50013-173

Balun Trasformer(20-4500MHz)

### ELECTRICAL SPECIFICATIONS@25°C:

Parameters (P#: ENA PORT)	frequency band	Min.	Typ.	Max.	Unit
Port Impedance, Z0 (P1 / P2 / P3)			50/75/75		Ohm
Insertion Loss	20-4500MHz		1.6	3.0	dB
Phase Balance	20-4500MHz		4.0		Deg
Amplitude Balance	20-4500MHz		0.5		dB

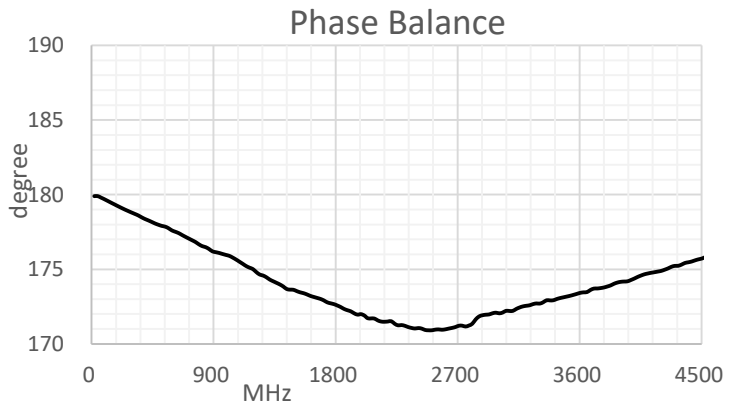
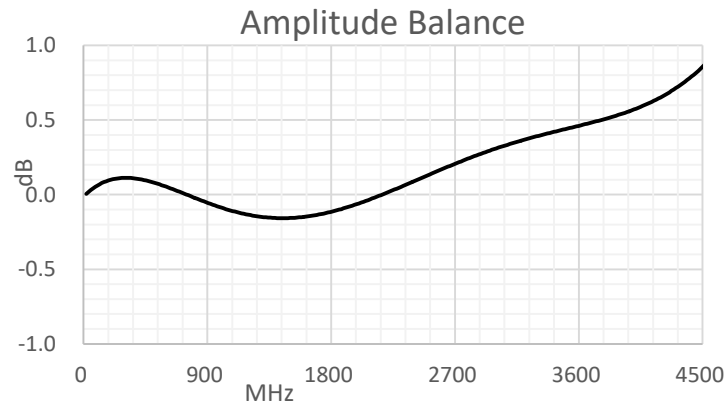
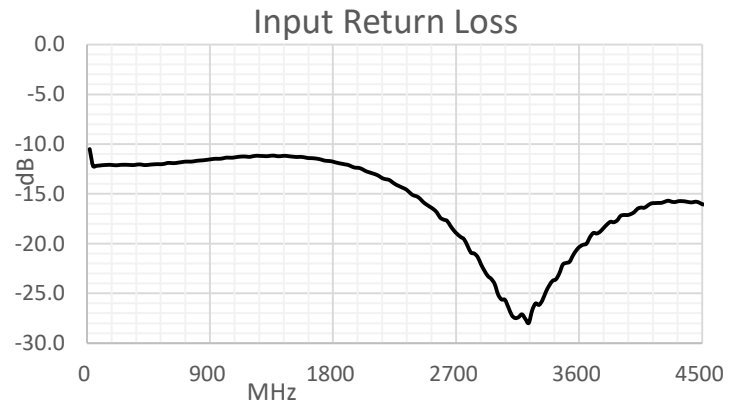
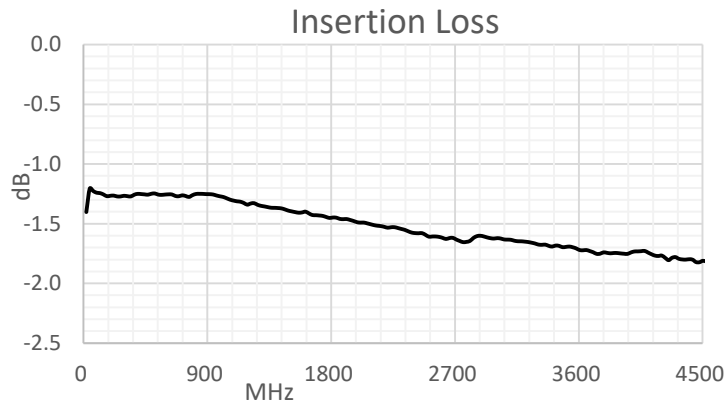



# Apps Electronics Limited 雅思電子有限公司

位址: 香港九龍新浦崗大有街29號宏基中心1407室

電話 +852 36934218

傳真 +852 37436367

位址: 廣東省深圳市福田區深南大道南 泰然九路喜年中心A座1720室

電話 +86 (755) 86538552 傳真 +86 (755) 26653184

ABT-P13-50013-173

Balun Trasformer(20-4500MHz)

## PACKAGE

DIRECTION OF FEED

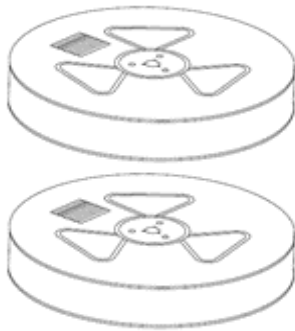
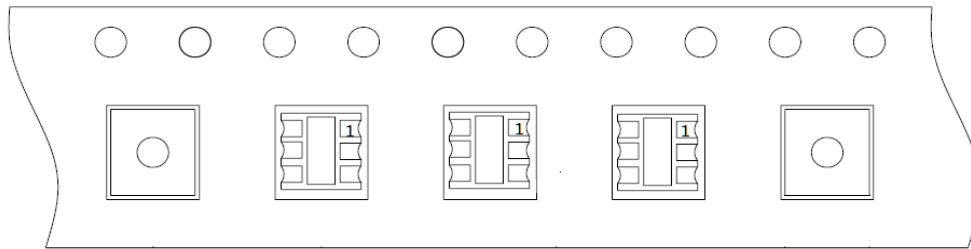

NineReel

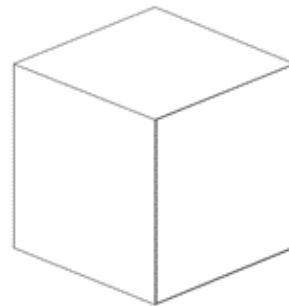

Export Carton

Quantity per reel: 2000 pcs

Quantity per export carton: 20000 pcs