



Apps Electronics Limited

雅思電子有限公司

位址：香港九龍新浦崗大有街29號宏基中心1407室

電話 +852 36934218

傳真 +852 37436367

位址：廣東省深圳市福田區深南大道南 泰然九路喜年中心A座1720室

電話 +86 (755) 86538552 傳真 +86 (755) 26653184

ABT-P12-50012-263

Balun Trasformer(20-4500MHz)

DESCRIPTION

SCOPE

- ABT-P12-50012-263 is a 1:2 balun transformer in a SMT package.

APPLICATIONS

- Ideally suitable for PCS, wideband push-pull amplifiers and cellular applications.

FEATURES

- Surface mount
- Impedance ratio: 1:2
- Balanced transmission line
- RoHS compliant
- 260°C reflow compatible

PART NUMBER

ABT - P12 - 50012 - 263
 ①② - ③④ - ⑤ - ⑥

- ① Apps Electronics Limited
- ② Product series
- ③ Form Factor
- ④ Size Number
- ⑤ Impedance/Ratio
- ⑥ Design series Code

Form Factor

B: Bobbin/Pin Base

P: PCB base

C: Ceramic base or SMD core

F: Ferrite SMD core

Other...

12: Form sequence code

50012: 50 ohm, 1 : 2 Ratio

263: Design series Code

Series	Function description
BT/BL/WB	Balun Transformer
PD/PS	Power Divider/Power Splitter
PC	Power Combiner
CP	Directional Coupler, branch line hybrid/coupler
CL	Coupler+LPF
TF	RF Transformer(non-Balun, SE/SE, BA/BA)
LP/HP/BP/DP/TP	Filter(Lowpass/Highpass/Bandpass/Diplexer/Triplexer)
PT/PM	Power Transformer/Power Module
CM	C.M. Choke
E	Lan Transformer/RJ45/Air Coil
	Other...

FUNCTIONAL SCHEMATIC

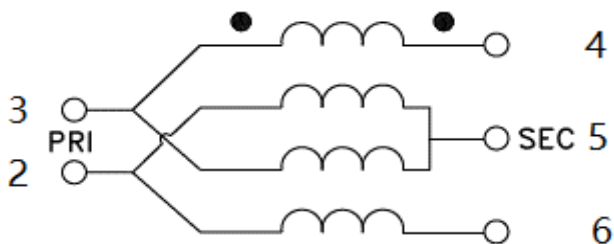

PIN CONFIGURATION

Pin No.	Function
1	Not used(ground)
2	Primary(Ground)
3	Primary Dot
4	Secondary Dot
5	Ground
6	Secondary



Apps Electronics Limited

雅思電子有限公司

位址: 香港九龍新浦崗大有街29號宏基中心1407室

電話 +852 36934218

傳真 +852 37436367

位址: 廣東省深圳市福田區深南大道南 泰然九路喜年中心A座1720室

電話 +86 (755) 86538552 傳真 +86 (755) 26653184

ABT-P12-50012-263

Balun Trasformer(20-4500MHz)

DIMENSIONS

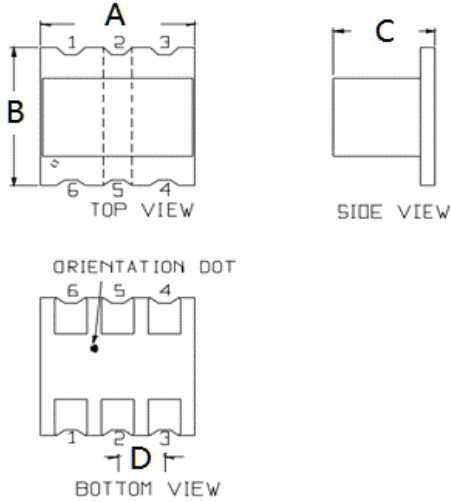

A	B	C
4.30	4.30	3.00
D		
1.27		

Unless otherwise stated dimensions are in mm

Tolerance: .xx ± 0.25, .xxx ± 0.05

RECOMMENED LAND PATTERN

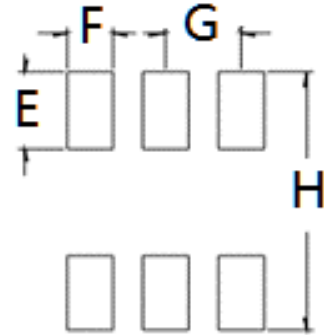

E	F	G
1.40	0.76	1.27
H		
4.83		

APPLICATION & TEST CIRCUIT

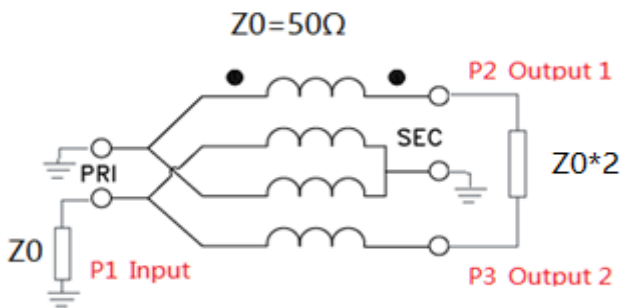

ABSOLUTE MAXIMUM RATINGS

Parameter	Value
RF Power	0.4W
DC Current	30mA
Operating Temperature Range	-40 to 85°C
Storage Temperature Range	-55 to 100°C



Apps Electronics Limited

雅思電子有限公司

位址：香港九龍新浦崗大有街29號宏基中心1407室

電話 +852 36934218

傳真 +852 37436367

位址：廣東省深圳市福田區深南大道南 泰然九路喜年中心A座1720室

電話 +86 (755) 86538552 傳真 +86 (755) 26653184

ABT-P12-50012-263

Balun Trasformer(20-4500MHz)

ELECTRICAL SPECIFICATIONS@25°C:

Parameters (P#: ENA PORT)	frequency band	Min.	Typ.	Max.	Unit
Port Impedance, Z0 (P1 / P2 / P3)			50/75/75		Ohm
Insertion Loss	20-4500MHz		2.3	3.0	dB
Phase Balance	20-4500MHz		12.0		Deg
Amplitude Balance	20-4500MHz		0.5		dB

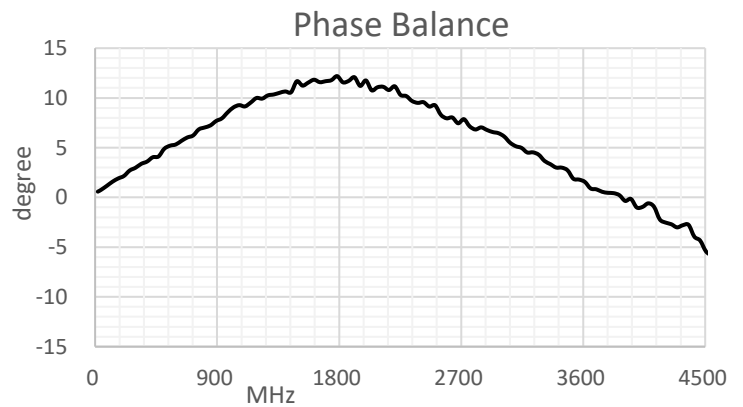
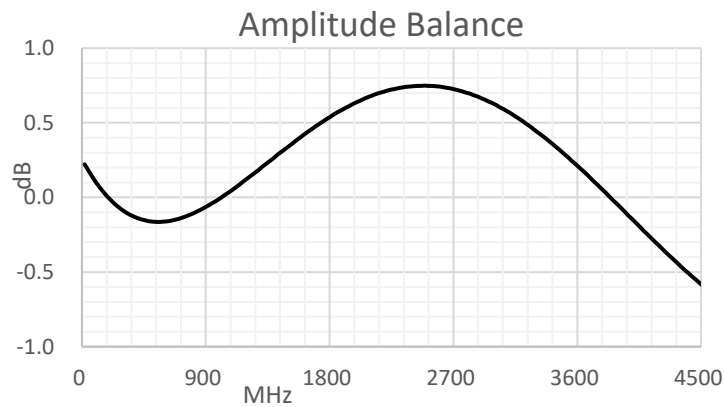
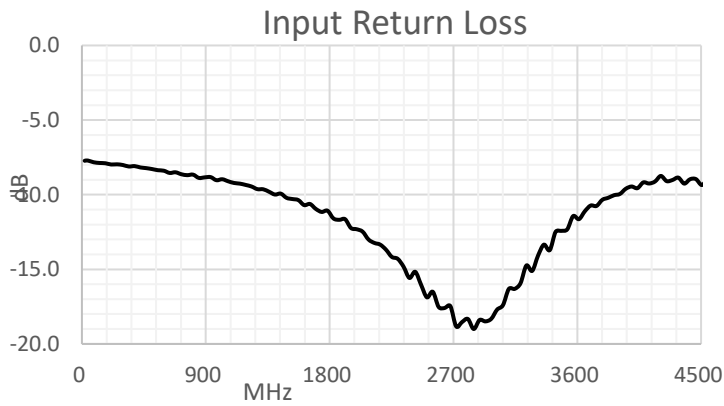



位址: 香港九龍新浦崗大有街29號宏基中心1407室

電話 +852 36934218

傳真 +852 37436367

位址: 廣東省深圳市福田區深南大道南 泰然九路喜年中心A座1720室

電話 +86 (755) 86538552 傳真 +86 (755) 26653184

ABT-P12-50012-263

Balun Trasformer(20-4500MHz)

PACKAGE

DIRECTION OF FEED

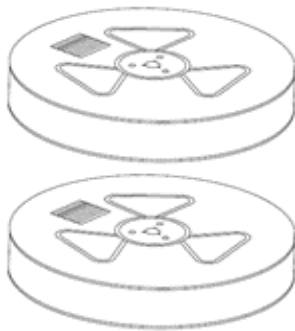
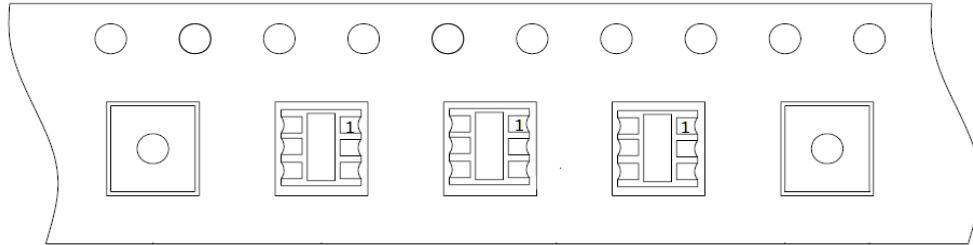

NineReel

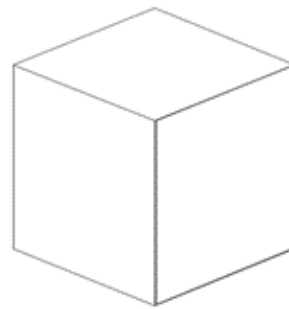

Export Carton

Quantity per reel: 2000 pcs

Quantity per export carton: 20000 pcs